



**Labate**  **Co**  
THE PROFILERS

## ***IHRE VORTEILE***

*Komplettes Programm*

*Nützliches Zubehör*

*Unser Fachwissen*

*Ausgezeichnetes Preis-Leistungs-Verhältnis*

**LABATE & CO. GMBH & Co. KG**  
KLEINBAHNSTRASSE 19  
59759 ARNSBERG

TELEFON +49 2932 90232-0  
TELEFAX +49 2932 90232-29

EINGETRAGEN IM HANDELSREGISTER ARNSBERG  
HRB 9044  
PERSÖNLICH HAFTENDE GESELLSCHAFTERIN  
LABATE & CO. VERWALTUNGS GMBH  
SITZ ARNSBERG  
GESCHÄFTSFÜHRER NATALINO LABATE  
FINANZAMT ARNSBERG  
STEUER-Nr.: 303/5822/0852  
UMSATZSTEUER-ID-Nr.: DE269984115

# Inhalt

## Produkte

## Products

### 01. Wandmontage

Profil PrintFrame light .....	5
Profil PrintFrame heavy .....	5
Profil 2-Kanal-Schiene .....	6
Fahnen & Ausleger .....	6
Plattenhalter .....	7
L&Co-Kit .....	7
SPIDER .....	8
SPIDER .....	9

### 02. Abhängung

Profil oben/unten .....	10
Profil Q-50 .....	11
Profil DADO 5 .....	12
Profil 2-Kanal gebogen .....	13
Profil PrintFrame DUO 50 gebogen .....	14
Profil PrintFrame DUO 50 Deckenscheibe .....	14
Profil Q-Heavy .....	15
L&Co-Kit .....	15

### 03. Freistehender

Freistehendes Display .....	16
Schnellaufsteller .....	16
Raumteiler .....	17
Stellwände .....	18
Freistehende Zylinder .....	19

## Trägersysteme für digitale GROSSBILDER

UNSERE LÖSUNGEN FÜR IHRE IDEEN.

DAS ist unser JOB.

**Labate**  **Co**  
THE PROFILERS



# WANDMONTAGE

## Profil PrintFrame light

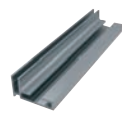

**25000**  
PrintFrame light gelocht  
Zuschnitt in mm  
PrintFrame light punched  
cutted in mm



**25100**  
PrintFrame Eckverbinder  
innen einfach  
PrintFrame inside corner  
connector single



**25102**  
PrintFrame Verbinder  
innen einfach  
PrintFrame inside  
connector single



**25350**  
Wandhalter PrintFrame light  
inkl. Befestigungsmaterial  
wall holder PrintFrame light  
incl. fixing material



**25050**  
PrintFrame light gel. gebogen  
je angef. LFM  
PrintFrame light punched bent,  
per running meter  
Min.-Radius: 500 mm



**25150**  
PrintFrame Eckverbinder innen  
einfach gebogen  
PrintFrame inside corner con-  
nector single bent



**25152**  
PrintFrame Schienenverbinder  
innen einfach gebogen  
PrintFrame inside connector  
single bent

# WANDMONTAGE

## Profil PrintFrame heavy

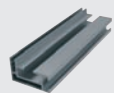

**25001**  
PrintFrame heavy  
Zuschnitt in mm  
PrintFrame heavy  
cutted in mm



**25101**  
PrintFrame Eckverbinder  
innen doppelt  
PrintFrame inside corner  
connector double



**25103**  
PrintFrame Verbinder  
innen doppelt  
PrintFrame inside  
connector double



**25351**  
Wandhalter PrintFrame heavy  
inkl. Befestigungsmaterial  
wall holder PrintFrame heavy  
incl. fixing material



**25051**  
PrintFrame heavy gebogen  
PrintFrame heavy bent  
Min.-Radius: 500 mm



**25151**  
PrintFrame Eckverbinder innen  
doppelt gebogen  
PrintFrame inside corner  
connector double bent



**25153**  
PrintFrame Schienenverbinder  
innen doppelt gebogen  
PrintFrame inside connector  
double bent

# WANDMONTAGE

## Profil 2-Kanal-Schiene



Sample dimension 6 x 6 m



**11002**  
2-Kanal-Schiene rund, Zuschnitt  
in mm (ohne Gehrungsschnitte)  
Rail 2-channel round cutted in  
mm (excluding mitre cut)



**11003**  
2-Kanal-Schiene flach, Zuschnitt  
in mm (ohne Gehrungsschnitte)  
Rail 2-channel flat cutted in mm  
(excluding mitre cut)



**11201**  
Kedereinlage Indoor D = 7 mm  
Zuschnitt in mm  
Keder inlay indoor D = 7 mm  
cutted in mm



**11202**  
Kedereinlage Outdoor D = 8 mm  
Zuschnitt in mm  
Keder inlay outdoor D = 8 mm  
cutted in mm



**22009**  
Eckverbinder rund spannbar  
Corner connector tensible  
for 2-channel round



**22008**  
Eckverbinder flach spannbar  
Corner connector tensible  
for 2-channel flat



**13001**  
Endstopfen 2-Kanal rund PVC  
End cap 2-channel round PVC



**13002**  
Endstopfen 2-Kanal flach PVC  
End cap 2-channel flat PVC



**21201**  
Aufhängung oben/unten beste-  
hend aus Grundplatte und Auf-  
hängung inkl. Befestigungs-  
material  
Suspension adapter top/bottom  
base plate and suspension  
top/bottom, incl. fixing material



**21208**  
Abstandshalter für Aufhängung  
oben/unten verzinkt  
distance holder for suspension  
top/bottom

# WANDMONTAGE

## Fahnen & Ausleger



**11002**  
2-Kanal-Schiene rund Zuschnitt  
in mm (ohne Gehrungsschnitte)  
Rail 2-channel round cutted  
in mm (excluding mitre cut)



**11003**  
2-Kanal-Schiene flach Zuschnitt  
in mm (ohne Gehrungsschnitte)  
Rail 2-channel flat cutted  
in mm (excluding mitre cut)



**11201**  
Kedereinlage Indoor D = 7 mm  
Zuschnitt in mm  
Keder inlay indoor D = 7 mm  
cutted in mm



**21210**  
Aluminium- Flansch für Schiene  
2-Kanal rund zur Horizontal-  
oder Vertikalmontage Indoor  
Flange for 2-channel round



**21211**  
Profilhalter universal  
Wallholder universal



**13001**  
Endstopfen 2-Kanal rund PVC  
End cap 2-channel round PVC



**13002**  
Endstopfen 2-Kanal flach PVC  
End cap 2-channel flat PVC



**21206**  
Plattenhalter 1 - 6 mm  
inkl. Befestigungsmaterial  
panel support 1 - 6 mm  
incl. fixing material

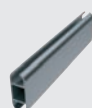
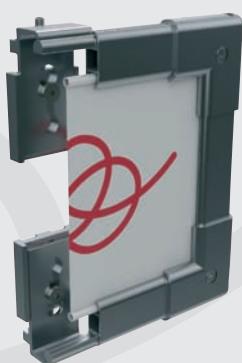

**60001**  
L&CO-KIT flach 750  
L&CO-KIT flat 750



**60002**  
L&CO-KIT rund 750  
L&CO-KIT round 750



**60011**  
L&CO-KIT flach 1500  
L&CO-KIT flat 1500



**60012**  
L&CO-KIT rund 1500  
L&CO-KIT round 1500

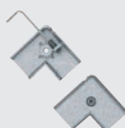

**60020**  
L&CO-KIT Eckverbinder flach  
L&CO-Kit Corner connector  
tensible for 2-channel flat



**60021**  
L&CO-KIT Eckverbinder rund  
L&CO-Kit Corner connector  
tensible for 2-channel round



**60024**  
L&CO-KIT 2 Schienenverbinder  
L&CO-KIT 2 Rail connector



**60025**  
L&CO-KIT 4 x Endstopfen flach  
PVC  
L&CO-KIT 4 x end cap 2-channel  
flat PVC



**60026**  
L&CO-KIT 4 x Endstopfen rund  
PVC  
L&CO-KIT 4 x end cap 2-channel  
flat PVC



**60030**  
L&CO-KIT Aufhängung oben/  
unten 2er Set  
L&CO-KIT wall mounting pack of 2

## SPIDER

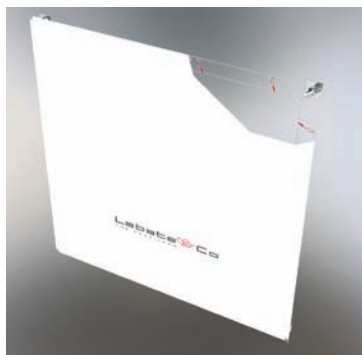

SPIDER  
Outdoor-Frame SPIDER  
SPIDER  
Outdoor-Frame SPIDER



60100  
L&CO-KIT  
Outdoor-Frame SPIDER (4er-Set)  
L&CO-KIT  
Outdoor-Frame SPIDER  
Pack of 4



60101  
L&CO-KIT  
Outdoor-Frame SPIDER (1 Stück)  
L&CO-KIT  
Outdoor-Frame SPIDER  
Pack of 1 pcs.



60110  
L&CO-KIT  
Seilset SPIDER 2 x 2 m  
L&CO-KIT  
Rope-set SPIDER 2 x 2 m



60111  
L&CO-KIT  
Seilset SPIDER 3 x 3 m  
L&CO-KIT  
Rope-set SPIDER 3 x 3 m



60112  
L&CO-KIT  
Seilset SPIDER 4 x 4 m  
L&CO-KIT  
Rope-set SPIDER 4 x 4 m



60113  
L&CO-KIT  
Seilset SPIDER 5 x 5 m  
L&CO-KIT  
Rope-set SPIDER 5 x 5 m



SPIDER Detail  
SPIDER detail

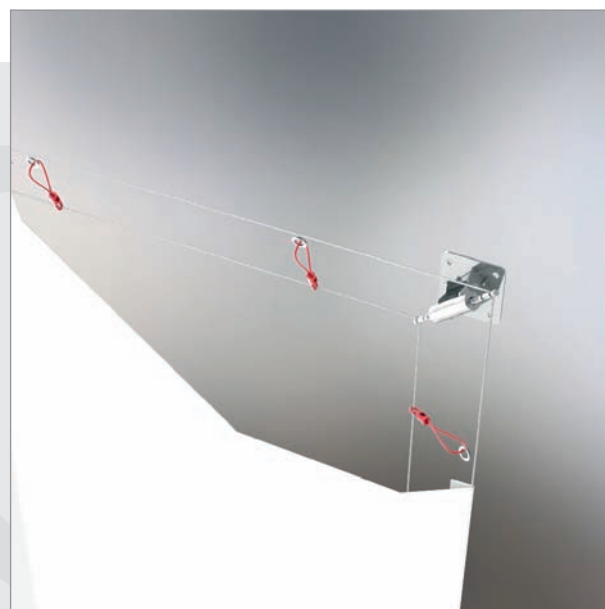

SPIDER Detail  
SPIDER detail

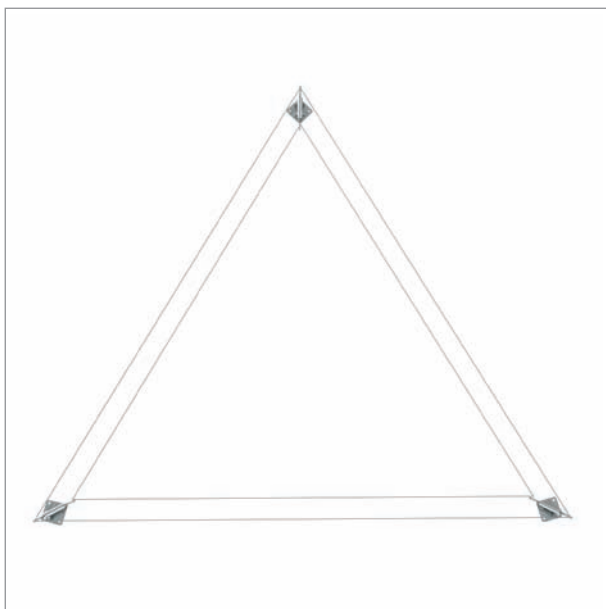

SPIDER dreieckig  
SPIDER triangular

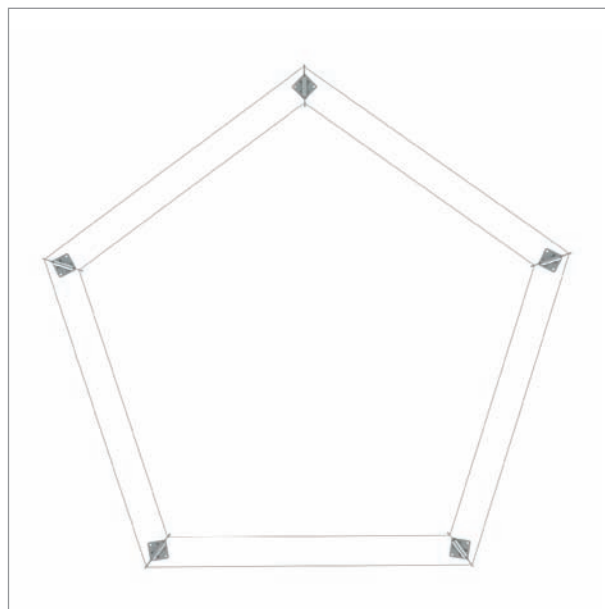

SPIDER fünfeckig  
SPIDER pentagonal

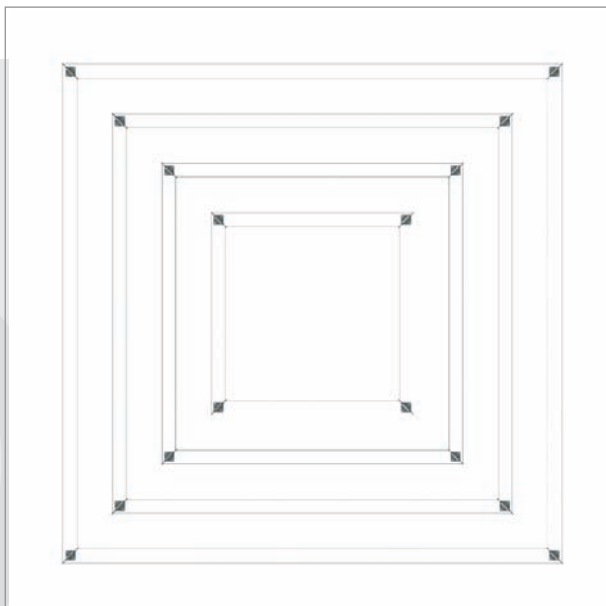

SPIDER quadratisch  
SPIDER square

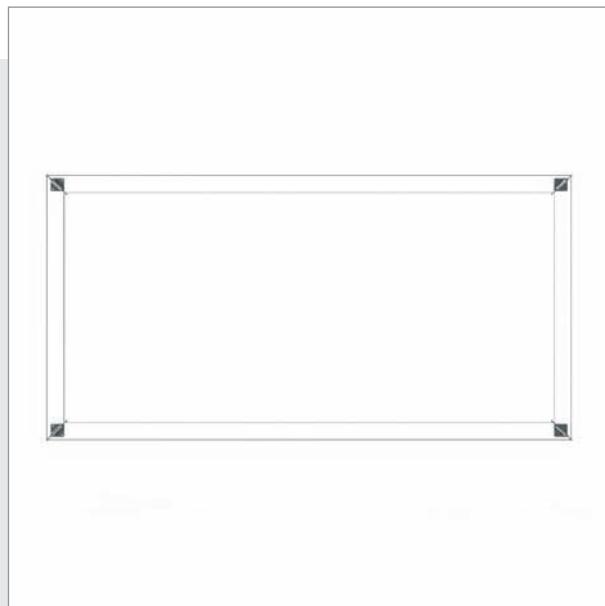

SPIDER rechteckig  
SPIDER rectangular

# ABHÄNGUNG

## Profil oben/unten

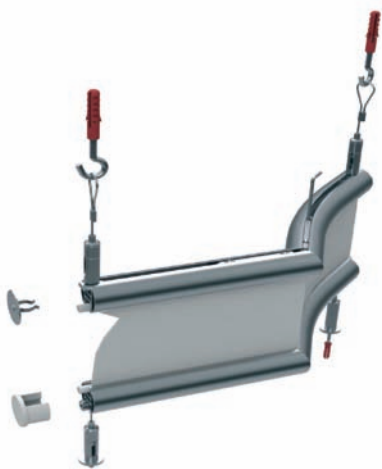

**11002**  
2-Kanal-Schiene rund Zuschnitt  
in mm (ohne Gehrungsschnitte)  
Rail 2-channel round cutted in  
mm (excluding mitre cut)



**12002**  
2-Kanal Schiene rund gebogen  
Rail 2-channel round bent  
Min.-Radius: 250 mm



**11003**  
2-Kanal-Schiene flach Zuschnitt  
in mm (ohne Gehrungsschnitte)  
Rail 2-channel flat cutted in mm  
(excluding mitre cut)



**12004**  
2-Kanal-Schiene flach gebogen  
Rail 2-channel flat bent  
Min.-Radius: 250 mm



**20000**  
Hakenschraube mit Konterstück  
Hook-screw with counter part



**14001**  
Kedereinlage Indoor 7 mm  
L = 6.000 mm  
Keder inlay indoor 7 mm  
L = 6.000 mm



**20001**  
Ösenschraube mit Konterstück  
Eye-screw with counter part



**20008**  
Seilhalter für alle Kederkanäle  
als Aufhängung mit Edelstahlseil  
D = 1,5 mm  
Wire fastener for all keder chan-  
nels as suspension with stainless  
steel wire, D = 1,5 mm



**20010**  
Boden-, Deckenhaken mit Dübel  
Floor-, ceiling hook  
incl. PVC rawlplug



**13001**  
Endstopfen 2-Kanal rund PVC  
End cap 2-channel round PVC



**20012**  
Schiengleiter  
für Drahtseil 1,5 mm  
Rail glider with lateral outlet  
for wire 1,5 mm



**13002**  
Endstopfen 2-Kanal flach PVC  
End cap 2-channel flat PVC



**20014**  
Boden-, Deckenhalter mit Seil-  
ausgang und Längsbohrung  
inkl. Befestigungsmaterial  
Floor-, ceiling kit with wire out-  
let, longitudinal drilling and  
incl. fixing material



**22008**  
Eckverbinder flach spannbar  
für 2-Kanal flach  
Corner connector tensible  
for 2-channel flat



**20020**  
Edelstahlseil mit 30 mm Schlaufe  
D = 1,5 mm, L = 3.000 mm  
Stainless steel wire with 30 mm  
loop, D = 1,5 mm, L = 3.000 mm



**22009**  
Eckverbinder rund spannbar  
Corner connector tensible  
for 2-channel round

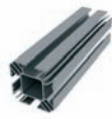

**51005**  
Schiene Q-50 Zuschnitt in mm  
(ohne Gehrungsschnitte)  
Rail Q-50 cutted in mm  
(excluding mitre cut)



**51009**  
Schiene Cover Zuschnitt in mm  
(ohne Gehrungsschnitte)  
Rail Cover cutted in mm  
(excluding mitre cut)



**57002**  
Verbinder lang 120 mm  
Connector long 120 mm



**57005**  
Verbinder quick lang  
Connector quick long



**57202**  
Q-50 Q-be 5/2  
Q-50 Q-be 5/2



**57203**  
Q-50 Q-be 5/3  
Q-50 Q-be 5/3



**57204**  
Q-50 Q-be 5/4  
Q-50 Q-be 5/4



**57205**  
Q-50 Q-be 5/5  
Q50 Q-be 5/5



**57206**  
Q-50 Q-be 5/6  
Q-50 Q-be 5/6



**20025**  
Schienengleiter  
für 3 mm Stahlseil  
rope-glider  
for 3 mm steel wire

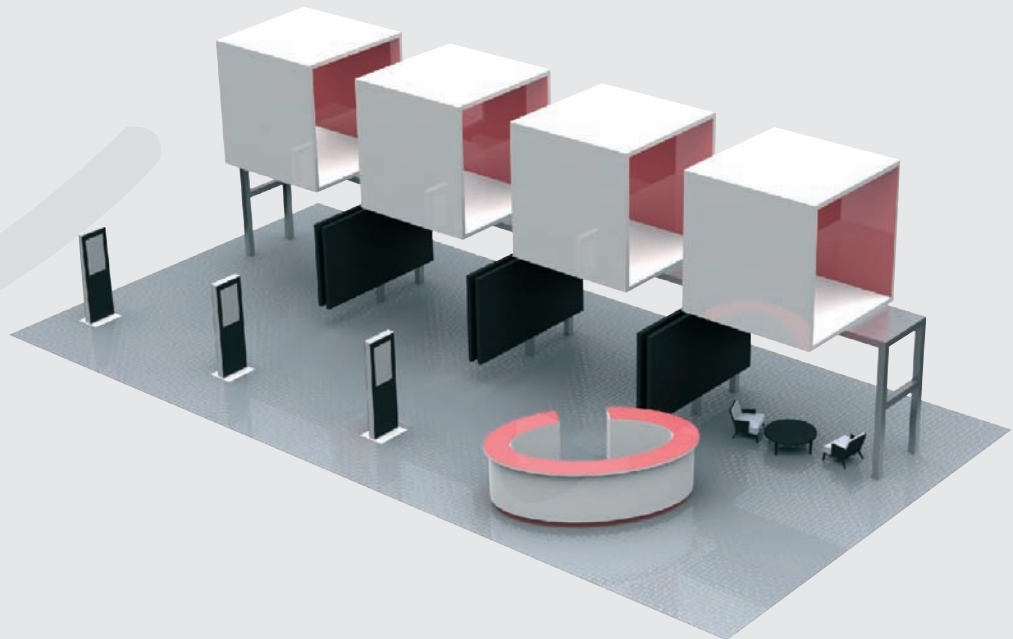

# ABHÄNGUNG

## Profil DADO 5

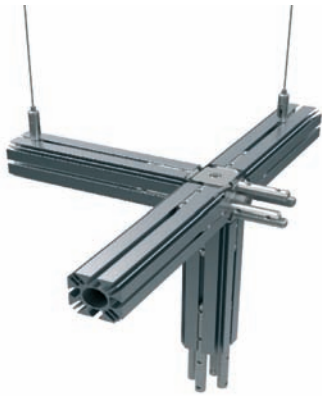

11102  
DADO 5 Zuschnitt in mm  
(ohne Gehrungsschnitte)  
DADO 5 rail cutted in mm  
(excluding mitre cut)



22102  
DADO Q-be 5/2  
DADO Q-be 5/2



22103  
DADO Q-be 5/3  
DADO Q-be 5/3



22104  
DADO Q-be 5/4  
DADO Q-be 5/4



22105  
DADO Q-be 5/5  
DADO Q-be 5/5



22106  
DADO Q-be 5/6  
DADO Q-be 5/6



22010  
Knotenblech zur Eckaussteifung  
Gusset plate



22001  
Schienenverbinder gerade  
L = 150 mm  
Rail connector, L = 150 mm



20002  
Ringschraube mit M6 Gewinde  
und Konterstück  
Eye bolt with counterpiece

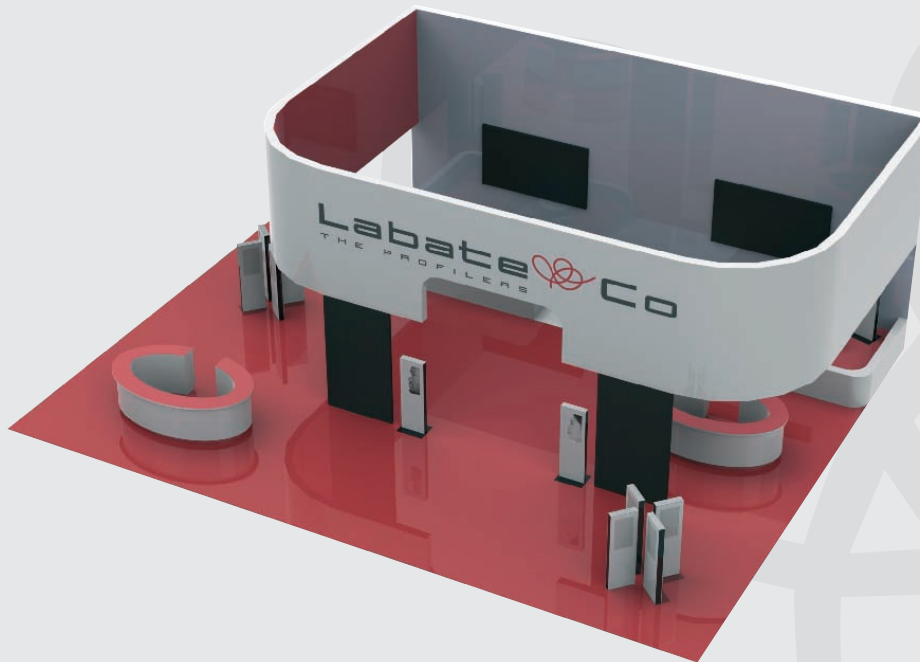

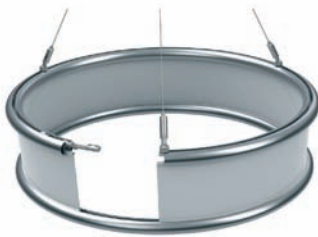

**12002**  
2-Kanal Schiene rund gebogen  
Rail 2-channel round bent  
Min.-Radius: 250 mm

**12004**  
2-Kanal-Schiene flach gebogen  
Rail 2-channel flat bent  
Min.-Radius: 250 mm

**14001**  
Kedereinlage Indoor 7 mm  
L = 6.000 mm  
Keder inlay indoor 7 mm  
L = 6.000 mm

**22004**  
Gelenk-Schienenverbinder  
für gebogene Schienen  
Joint-connector for bent rails

**22005**  
Schienenverbinder individuell  
vorgebogen, L = 150 mm  
Rail connector tailor made  
L = 150 mm

**20000**  
Hakenschraube mit Konterstück  
Hook-screw with counter part

**20001**  
Ösenschraube mit Konterstück  
Eye-screw with counter part

**20008**  
Seilhalter für alle Kederkanäle  
als Aufhängung mit Edelstahlseil  
D = 1,5 mm  
Wire fastener for all keder chan-  
nels for suspension with stain-  
less steel wire  
D = 1,5 mm

**20010**  
Boden-, Deckenhaken mit Dübel  
Floor-, ceiling hook  
incl. PVC rawlplug

**20012**  
Schienengleiter für Drahtseil  
1,5 mm  
Rail glider with lateral outlet  
for wire 1,5 mm

**20014**  
Boden-, Deckenhalter mit Seil-  
ausgang und Längsbohrung  
inkl. Befestigungsmaterial  
Floor-, ceiling kit with wire out-  
let, longitudinal drilling and  
fixing material

**20022**  
Schienengleiter mit Gelenk  
Rail glider with joint

**20020**  
Edelstahlseil mit 30 mm Schlaufe  
D = 1,5 mm, L = 3.000 mm  
Stainless steel wire with 30 mm  
loop  
D = 1,5 mm, L = 3.000 mm



# ABHÄNGUNG

## Profil PrintFrame DUO 50 gebogen



25052  
PrintFrame DUO 50 gebogen  
PrintFrame DUO 50 bent  
Min.-Radius: 500 mm



25003  
PrintFrame Zarge  
Zuschnitt in mm  
PrintFrame Zarge  
cutted in mm



25153  
PrintFrame Schienenverbinder  
innen doppelt gebogen  
PrintFrame inside connector  
double bent



25105  
PrintFrame Schloss  
PrintFrame lock



20022  
Schienengleiter mit Gelenk  
Rail glider with joint



20012  
Schienengleiter  
für Drahtseil 1,5 mm  
Rail glider with lateral outlet  
for wire 1,5 mm



20020  
Edelstahlseil mit 30 mm Schlaufe  
D = 1,5 mm, L = 3.000 mm  
Stainless steel wire with 30 mm  
loop  
D = 1,5 mm, L = 3.000 mm

# ABHÄNGUNG

## Profil PrintFrame DUO 50 Deckenscheibe



25053  
PrintFrame DUO 50 gebogen  
für Deckenscheibe  
PrintFrame DUO 50 bent  
for ceiling-panel round  
Min.-Radius: 500 mm



25154  
PrintFrame Schienenverbinder  
doppelt gebogen für Decken-  
scheibe  
PrintFrame rail connector double  
bent for ceiling panel



25155  
PrintFrame Schienenverbinder  
für Zarge gebogen  
PrintFrame rail connector for  
beam bent



20000  
Hakenschraube mit Konterstück  
Hook-screw with counter part



20001  
Ösenschraube mit Konterstück  
Eye-screw with counter part



20022  
Schienengleiter mit Gelenk  
Rail glider with joint



20020  
Edelstahlseil mit 30 mm Schlaufe  
D = 1,5 mm, L = 3.000 mm  
Stainless steel wire with 30 mm  
loop  
D = 1,5 mm, L = 3.000 mm



**51008**  
Schiene Q-Heavy Zuschnitt  
in mm (ohne Gehrungsschnitte)  
Rail Q-Heavy cutted in mm  
(excluding mitre cut)



**57002**  
Verbinder lang 120 mm  
Connector long 120 mm



**57003**  
3-D Verbinder  
3-D Connector



**57005**  
Verbinder quick lang  
Connector quick long



**53008**  
Endstopfen für Schiene  
Q-Heavy Aluminium  
Endcap for rail Q-Heavy  
aluminium



**20025**  
Schienengleiter  
für 3 mm Stahlseil  
rope-glider  
for 3 mm steel wire



**60001**  
L&CO-KIT flach 750  
L&CO-KIT flat 750



**60002**  
L&CO-KIT rund 750  
L&CO-KIT round 750



**60011**  
L&CO-KIT flach 1500  
L&CO-KIT flat 1500



**60012**  
L&CO-KIT rund 1500  
L&CO-KIT round 1500

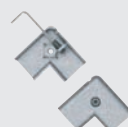

**60020**  
L&CO-KIT Eckverbinder flach  
L&CO-Kit corner connector  
tensible for 2-channel flat



**60021**  
L&CO-KIT Eckverbinder rund  
L&CO-Kit corner connector  
tensible for 2-channel round



**60023**  
L&CO-KIT 4 Schienengleiter  
mit 3-m-Seil und Schlaufe  
L&CO-KIT 4 rail glider with  
3-m-rope and loop



**60024**  
L&CO-KIT 2 Schienenverbinder  
L&CO-KIT 2 rail connector

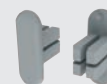

**60025**  
L&CO-KIT 4 x Endstopfen flach  
PVC  
L&CO-KIT 4 x end cap 2-channel  
flat PVC



**60026**  
L&CO-KIT 4 x Endstopfen rund PVC  
L&CO-KIT 4 x end cap 2-channel  
flat PVC

# FREISTEHER

## Freistehendes Display



**11002**  
2-Kanal-Schiene rund Zuschnitt  
in mm (ohne Gehrungsschnitte)  
Rail 2-channel rund cutted in  
mm (excluding mitre cut)



**11003**  
2-Kanal Schiene flach Zuschnitt  
in mm (ohne Gehrungsschnitte)  
Rail 2-channel flat cutted in mm  
(excluding mitre cut)



**11004**  
4-Kanal-Schiene rund Zuschnitt  
in mm (ohne Gehrungsschnitte)  
Rail 4-channel round cutted in  
mm (excluding mitre cut)



**21001**  
Standfuß oval flach, für 4-Kanal-  
Schiene rund, RAL 9006  
Foot oval flat for 4-channel-rail  
round, RAL 9006



**21003**  
Standfuß rund mit Betonkern  
für 4-Kanal-Schiene rund  
Foot round with concrete core  
for 4-channel-rail round



**22011**  
Querverbinder von 2-Kanal  
rund auf 4-Kanal rund neu  
Cross connector for rail  
2-channel round to 4-channel  
round new version



**22012**  
Querverbinder von 2-Kanal  
flach auf 4-Kanal rund neu  
Cross connector for rail  
2-channel flat to 4-channel  
round new version



**13103**  
Endstopfen 4-Kanal-Schiene  
Aluminium  
End cap for 4-channel-rail



**13104**  
Endstopfen 4-Kanal rund  
Aluminium  
End cap 4-channel round  
aluminium

# FREISTEHER

## Schnellaufsteller

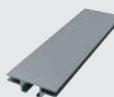
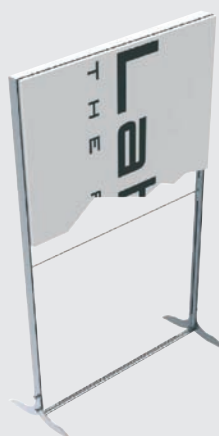

**51002**  
Schiene Q-Fit DUO  
Zuschnitt in mm (ohne Gehrungsschnitte)  
Rail Q-Fit DUO  
cutted in mm (excluding mitre  
cut)



**57004**  
2-D Verbinder quick  
2-D Connector quick



**57005**  
Verbinder quick lang  
Connector quick long



**11203**  
Rundrohr  
D = 8 mm  
Zuschnitt in mm  
Circular tube  
D = 8 mm  
cutted in mm



**21005**  
Standfuß seitlich für freistehendes Display in RAL 9006  
Foot flat for display in RAL 9006

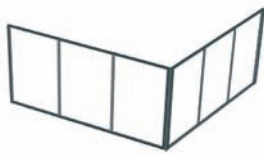

**25002**  
PrintFrame DUO 50  
Zuschnitt in mm  
PrintFrame DUO 50  
cutted in mm



**25003**  
PrintFrame Zarge  
Zuschnitt in mm  
PrintFrame Zarge  
cutted in mm

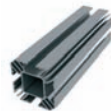

**51005**  
Schiene Q-50 Zuschnitt in mm  
(ohne Gehrungsschnitte)  
Rail Q-50 cutted in mm  
(excluding mitre cut)



**51009**  
Schiene Cover Zuschnitt berech-  
net in mm (ohne Gehrungs-  
schnitte)  
Rail Cover cutted in mm  
(excluding mitre cut)



**25101**  
PrintFrame Eckverbinder  
innen doppelt  
PrintFrame inside corner  
connector double



**25103**  
PrintFrame Verbinder  
innen doppelt  
PrintFrame inside  
connector double



**25105**  
PrintFrame Schloss  
PrintFrame lock



**25176**  
PrintFrame Systemverbinder  
DUO/DUO  
PrintFrame Connector  
DUO/DUO Set



**57100**  
Stellfuß für Schiene Q-50  
Feet for rail Q-50



**53005**  
Endstopfen für Schiene  
Q-50 Aluminium  
Endcap for rail Q-50 aluminium



**25380**  
Halogenstrahler 150 W silber  
für DUO 50 inkl. 5 m-Zuleitung  
Halogenspot 150 W silver  
for DUO 50 incl. 5 m cable



**25381**  
Halogenstrahler 150 W schwarz  
für DUO 50 inkl. Zuleitung  
Halogenspot 150 W black  
for DUO 50 incl. 5 m cable

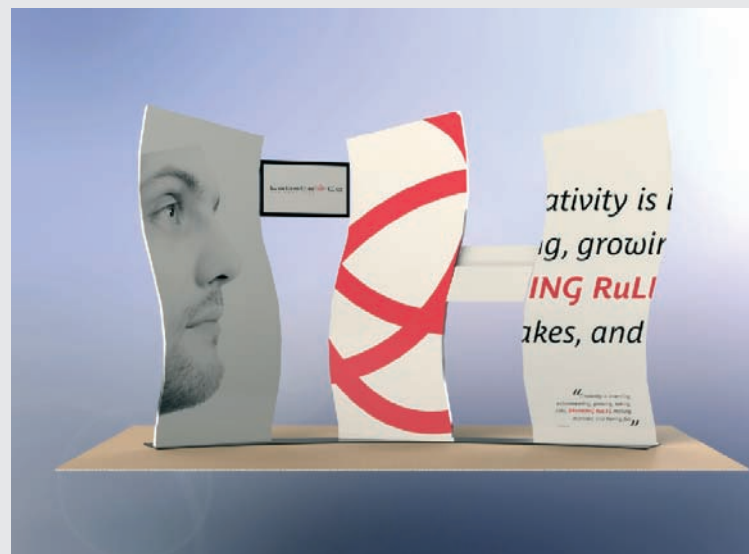



**25002**  
PrintFrame DUO 50  
Zuschnitt in mm  
PrintFrame DUO 50  
cutted in mm



**25003**  
PrintFrame Zarge  
Zuschnitt in mm  
PrintFrame Zarge  
cutted in mm



**25101**  
PrintFrame Eckverbinder  
innen doppelt  
PrintFrame inside corner  
connector double



**25103**  
PrintFrame Verbinder  
innen doppelt  
PrintFrame inside  
connector double



**25105**  
PrintFrame Schloss  
PrintFrame lock



**25108**  
PrintFrame Eckstabilisator  
PrintFrame corner stabiliser



**25109**  
Knotenblech für PrintFrame  
Gusset plate for PrintFrame



**25170**  
PrintFrame 30°-Verbinder  
PrintFrame 30°-connector



**25171**  
PrintFrame 45°-Verbinder  
PrintFrame 45°-connector



**25172**  
PrintFrame 90°-Verbinder  
PrintFrame 90°-connector



**25173**  
PrintFrame 180°-Verbinder  
PrintFrame 180°-connector



**25174**  
PrintFrame T-Verbinder  
PrintFrame T-connector



**25175**  
PrintFrame X-Verbinder  
PrintFrame X-connector



**25300**  
Standfuß PrintFrame flach  
Foot PrintFrame flat packed



**25301**  
Standfuß PrintFrame Trapez 500  
Foot PrintFrame Trapez 500



**25380**  
Halogenstrahler 150 W silber  
für DUO 50 inkl. 5 m-Zuleitung  
Halogenspot 150 W silver  
for DUO 50 incl. 5 m cable



**25381**  
Halogenstrahler 150 W schwarz  
für DUO 50 inkl. Zuleitung  
Halogenspot 150 W black  
for DUO 50 incl. 5 m cable

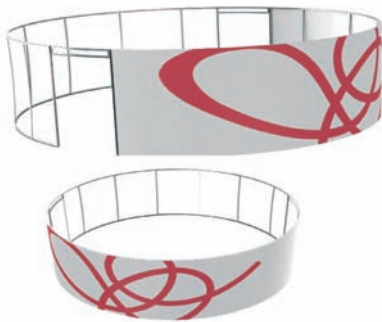

**25052**  
PrintFrame DUO 50 gebogen  
PrintFrame DUO 50 bent  
Min.-Radius: 500 mm



**25002**  
PrintFrame DUO 50  
Zuschnitt in mm  
PrintFrame DUO 50  
cutted in mm



**25003**  
PrintFrame Zarge  
Zuschnitt in mm  
PrintFrame Zarge  
cutted in mm



**25153**  
PrintFrame Schienenverbinder  
innen doppelt gebogen  
PrintFrame inside connector  
double bent



**25151**  
PrintFrame Eckverbinder  
innen doppelt gebogen  
PrintFrame inside corner  
connector double bent



**25380**  
Halogenstrahler 150 W silber  
für DUO 50 inkl. 5 m-Zuleitung  
Halogenspot 150 W silver  
for DUO 50 incl. 5 m cable



**25381**  
Halogenstrahler 150 W schwarz  
für DUO 50 inkl. Zuleitung  
Halogenspot 150 W black  
for DUO 50 incl. 5 m cable

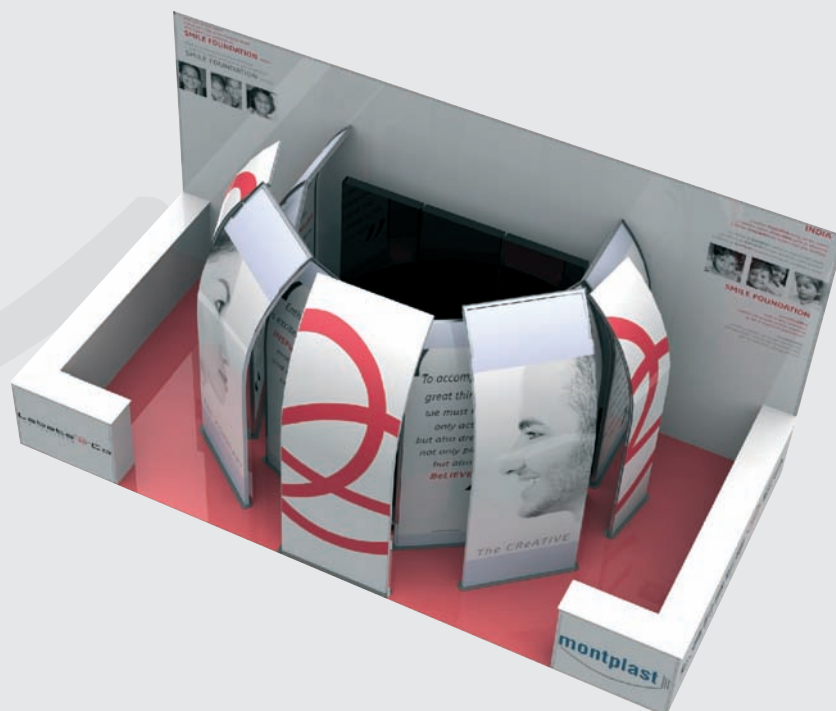

Labate & Co. GmbH & Co. KG  
Kleinbahnstraße 19  
59759 Arnsberg

TELEFON +49 2932 90232-0  
TELEFAX +49 2932 90232-29

[www.labateandco.com](http://www.labateandco.com)